

1. Accessories & Dimension

☒ Please check if all the camera and accessories are included in the package.

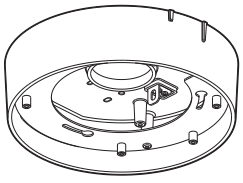

Junction Bracket Manual Multi-Sensor Outdoor Dome Camera

Quick Manual

Ver. 1.1 / 2021.11

Before installing and using the Camera, please read this manual carefully. Be sure to keep it handy for future reference.

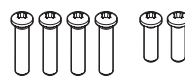
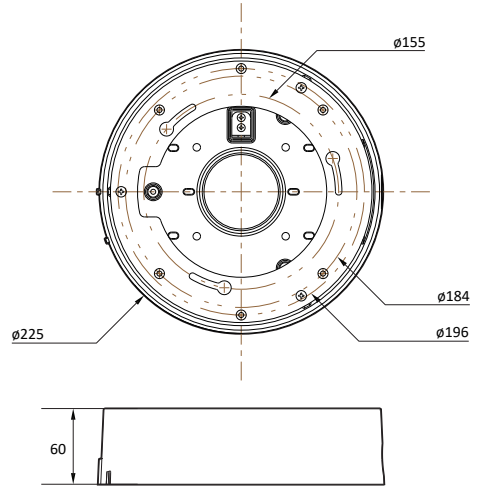

Gang Box Install Screw
Type A : 4ea / Type B : 2ea



Mount Screw

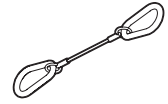

Safety Wire



Manual

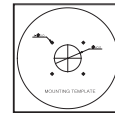

Mount Template

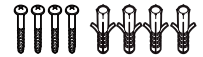

Screw & Plastic Anchor-4pcs

2. Installation

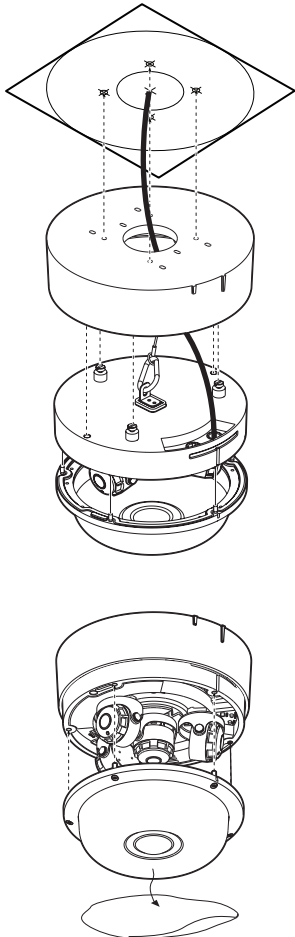

- 1 Install it on the wall/ceiling according to the template sheet. Secure it with a screw.
- 2 Connect Safety Wire to Head and Camera.
- 3 Tighten the camera to fit the 3 holes. At this time, tighten it to fit the joint.



- 4 After tightening, secure it with two mount screws.
- 5 Secure the dome cover to the camera's bottom case using the torx wrench.
- 6 Remove the protective film from the camera's dome to complete the installation.

Mounting Junction Box to Gang Box (Optional)

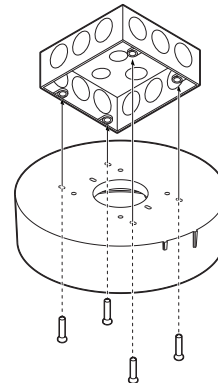

Type A : 2-Gang Handy Boxes / Switch Boxes

2-GANG HANDY BOXES / SWITCH BOXES

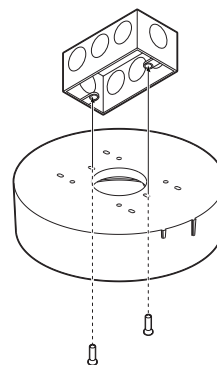
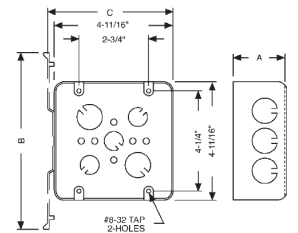

Type B : Handy Boxes

HANDY BOXES

